

Konftel 55Wx Quick Reference Guide

The **Konftel 55Wx** is a conference unit that can be connected to your desktop phone, mobile phone and computer. It transforms your communication tools into conference phones using Konftel's unique audio technology, OmniSound®.

On / Off (long press)

Mute (microphone off / speaker off)

NFC symbol

Touch screen



LEDS

Flashing blue

Incoming call via Bluetooth

Steady blue light

Sound channel on / call in progress

Steady red light

Mute, microphone off

Flashing red

Hold, microphone and speaker turned off

DESCRIPTION

The Konftel 55Wx automatically detects the connections you make. When you connect a mobile phone, the screen displays a button for activating the audio stream from the mobile. When you insert an SD card, a button to record onto the card is displayed. A lit button indicates that the feature is active. When you press the button, it switches between on and off.

The Konftel 55Wx has expanded support for UC solutions, such as Microsoft® Lync®. For more information about this and the product's other functions, visit www.konftel.com.

Ports for expansion microphones Battery cover

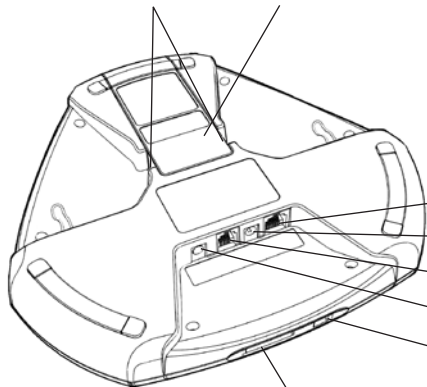

Connection for:

Desktop phone (adapter)

Power supply

Mobile phone

Headset (3.5 mm)

Computer (mini USB)

Port for SD memory card

It is possible to record a call in progress and use the Konftel 55Wx as a dictaphone.

Insert an SD card and press the record button to start recording.

Recordings can be accessed via the menu.



What the screen can look like.

Here a Bluetooth phone is connected and a computer is connected and active.

The  key is only shown if the telephone supports Bluetooth A2DP for playing music.

The  icon shows the mobile phone's signal strength.

DESKTOP PHONE

Connection to a desktop phone

- ⇒ Connect the phone to the Konftel 55Wx using a phone adapter (accessory).

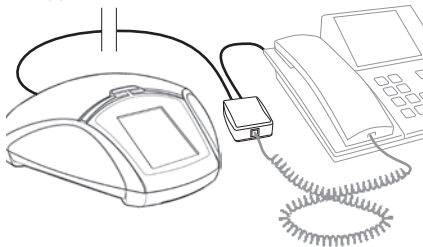

The  button is displayed on the Konftel 55Wx.



Unplug the telephone handset cable from the phone and connect it to the adapter as illustrated above.

- ⇒ Make a test call to check that the receiving party has a good sound level.
- ⓘ It is possible to adjust the Konftel 55Wx's microphone volume to achieve optimal performance with the phone being used. (See the user guide)

Making calls

- ⇒ Press  on the Konftel 55Wx to transfer the sound from the phone to the Konftel 55Wx.
The  button and the LEDs light up blue.
- ⇒ Lift the handset and make a call using the desktop phone.
- ⓘ Press the  button to move the sound to and from the desktop phone's handset.



MOBILE PHONE

Cable connection to a mobile phone

- ⇒ Connect the mobile phone to the Konftel 55Wx. (You will need an accessory cable for your phone.)
The  button is displayed on the Konftel 55Wx.

- ⇒ Make a test call to check that the receiving party has a good sound level.
- ⓘ It is possible to adjust the Konftel 55Wx's microphone volume to achieve optimal performance with the phone being used. (See the user guide)
- ⓘ Note that it is not possible to use a desktop phone and a mobile phone at the same time with the Konftel 55Wx. The desktop phone connection is disabled when the mobile phone is connected.

Making calls

- ⇒ Press the  button on the Konftel 55Wx to transfer the sound from the mobile to the Konftel 55Wx.
The  button and the LEDs light up blue.
- ⇒ Make a call using the mobile phone.
- ⓘ Press the  button to move the sound to and from the mobile phone.

Connection to a computer

⇒ Connect your computer to the Konftel 55Wx using the USB cable provided.

The  button is displayed on the Konftel 55Wx and USB audio is activated.

- ① Depending on the computer's operating system, you may need to change the setting so that the **Konftel 55Wx** can be used as an audio unit.
- ① The Konftel 55Wx can be recharged and powered via USB provided the battery is inserted. It is not necessary to have the power adapter connected.

Using the Konftel with a computer

- ⇒ Press the  button on the Konftel 55Wx if it is not already lit up blue.
- ⇒ Connect the call to the computer using, for example, web conference software or Skype®.
- ① It is possible to bridge calls via a connected telephone and computer by activating both connections.
- ① The Konftel 55Wx also has expanded support for certain UC solutions (e.g. Microsoft® Lync®). More information about the UC solutions supported is available at www.konftel.com.



Connecting a phone with Bluetooth

Bluetooth has to be activated in the Konftel 55Wx and in your mobile phone.



Pairing and connection with NFC

- ① Your phone must support simplified pairing through NFC (near-field communication). NFC must be activated on your mobile phone and the screen unlocked.
- ⇒ Hold the phone next to the NFC symbol  on the curved metallic strip to the right of the Konftel 55Wx display.
The phone and the Konftel 55Wx are paired and connected.

Pairing and connection without NFC

- ⇒ Press the  key on the Konftel 55Wx.
This opens the dialogue window displaying paired devices and makes the Konftel 55Wx visible to other Bluetooth devices.
- ⇒ Activate Bluetooth on your mobile phone, set it to search and select Konftel 55Wx to pair it with your phone.
- ① You can also search for the mobile phone from the Konftel 55Wx by pressing .

When you next want to use the Konftel 55Wx with your phone, simply connect it:

- ⇒ Press the  key on the Konftel 55Wx.
This displays a list of already paired devices.
- ⇒ Select your phone from the list and press .



Call mode and music mode

Most mobile phones and computers support two ways to transmit audio via Bluetooth.

One is two-way and optimised for speech while the other has higher audio bandwidth, is one-way and optimised for music.



The Konftel 55Wx music mode is usually activated when a mobile phone or computer uses a music app to play audio. The call mode is activated when a mobile phone or computer uses a communication app to play audio. You can switch between the modes using the  key on the Konftel 55Wx.

Find out more about the music mode in the manual which is available at www.konftel.com.

The  and  keys are displayed on the Konftel 55Wx in call mode. You will also see the name of your phone and its signal strength.

Making calls

⇒ To make a call, press  (in call mode) and key in the number.

- ① The call can be transferred between the Konftel 55Wx and the mobile phone by pressing  and  respectively.
- ① It is also possible to make a call from the mobile phone and then press  to move the call to the Konftel 55Wx.

